

Décor components

Hanging drawers, gliding accessory racks,
Décor shelves and fascia

NOTE!

Install hanging drawers, gliding accessory, décor shelves and fascia before installing wire shelves.

Décor gliding components and drawer frame are all installed with the same U-shaped metal glide.

If you would like more space between drawers, simply move them to the desired position.

1

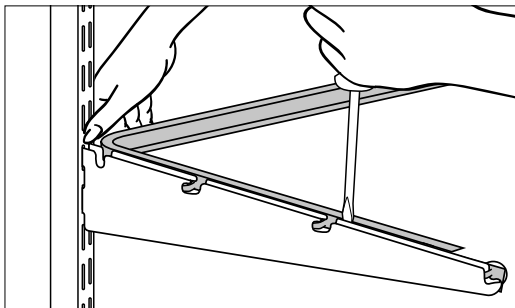
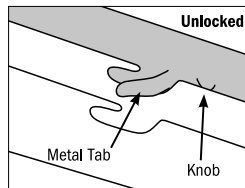
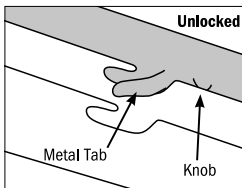
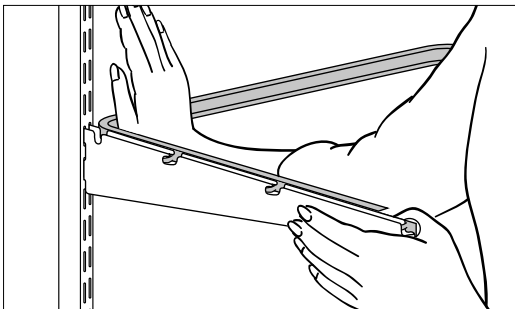

Install the U-Shaped metal glide

The U-Shaped metal glide has three metal tabs and a metal knob on each side (located at the top of the glide) that locks the glide into the bracket click in.

- Begin with the left bracket click in. Align the metal tabs on the U-shaped metal glide with the cutout notches of the bracket click in.
- When aligned, hold the front of the bracket and press on the U-shaped metal glide at the back rounded corner until you hear it lock into place.
- Repeat on the right side.

Reposition and remove

To REPOSITION the U-shaped metal glide: It is not necessary to remove the glide from the brackets.

Simply tilt up the front of both brackets and remove them from the hang standards. Place in the desired location.

To REMOVE the U-shaped metal glide from the brackets: Place one hand at the back of the glide.

With your thumb on the hang standard, gently push the glide forward with your fingers.

At the same time, insert and twist a small flat head screwdriver between the bracket and U-shaped metal glide in front of the knob holding the glide in place.

The U-shaped metal glide should pop out of the bracket. Repeat on the other side.

2

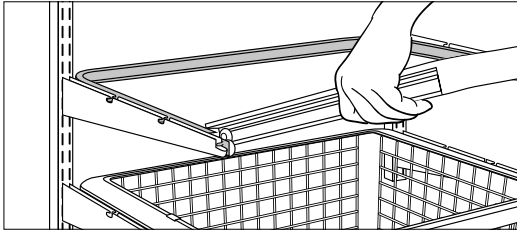

Install the gliding drawer frames

Align the rollers on each side of the frame with the openings in the U-shaped metal glide. Slide the frame into the glide.

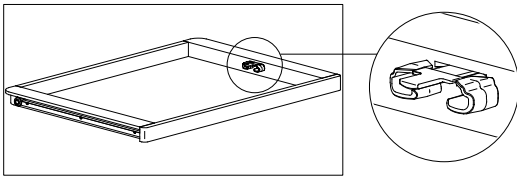

Insert drawers

Always start with the bottom drawer and work up.

For drawers, insert the drawer into the frame opening and attach it to the left and right side of the wood frame with the drawer clips provided.

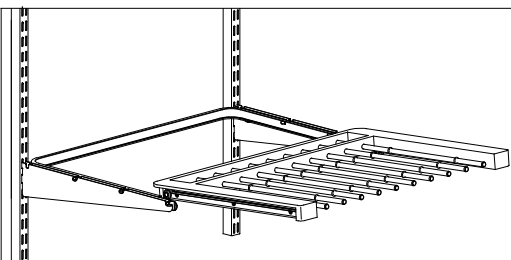
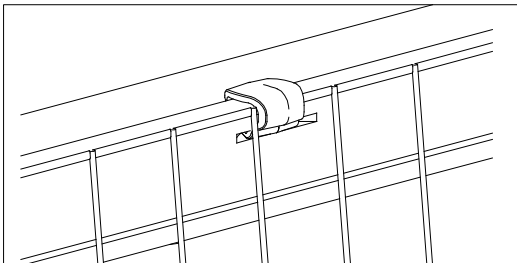
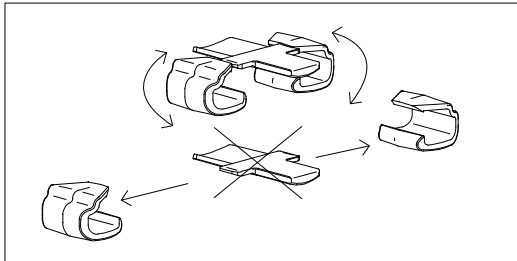

Insert pant rack

Align the rollers on each side of the frame with the openings in the U-shaped metal glide. Slide the pant rack into the glide.

Gliding accessories and décor shelves

Install gliding accessories and décor shelves

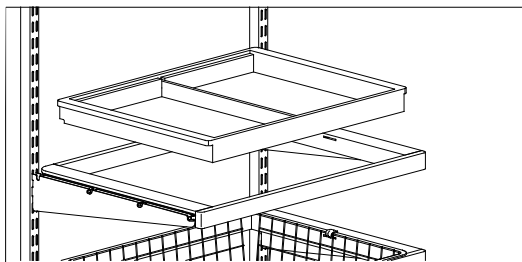

Insert accessory tray

Place the accessory tray in a drawer frame. If requested add a 8-space or 24-space divider, and/or a lid.

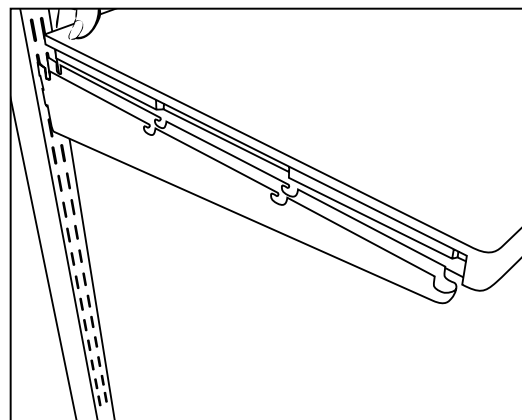
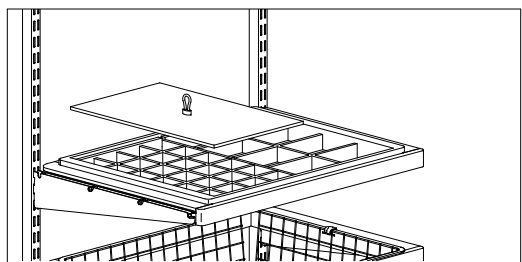

To install a décor shelf

Insert bracket click in into the hang standards at the desired height.

Place the décor shelf over the bracket click in and press down to snap into place.

Add bracket covers.

Décor components

To install fascia on wire shelf

NOTE! Position **ALL** pieces of fascia before installing clips.

1

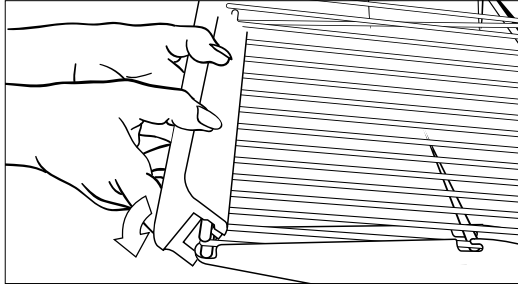

Position the fascia

Position the fascia with the opening facing the wire shelf. The notch in the fascia that hooks onto the front support wires of the wire shelf should be at the top. Hook over the top wire with a downward motion, and secure it to the front of the shelf.

Use the included clips to secure the fascia to the wire shelf.

A

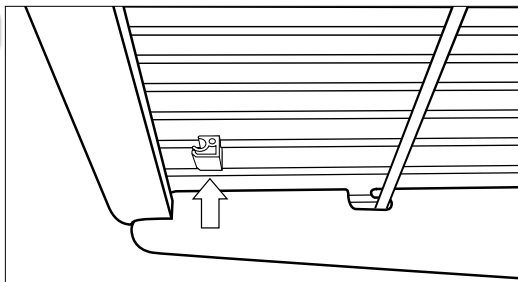

The top of the clip features a groove that accommodates one shelf wire. (Figure A) Once it's attached to the underside of a shelf wire, slide it all the way to the front of the shelf and into the opening of the fascia for a secure hold. (Figure B).

B

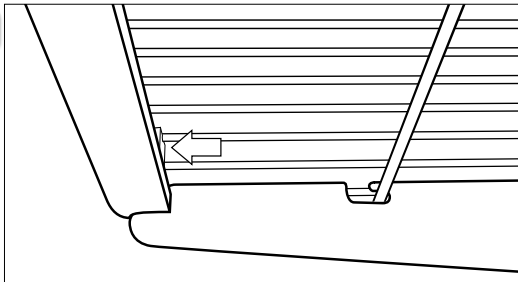

Repeat with another clip at the opposite end of the fascia. Add the third clip at the center of the fascia.